

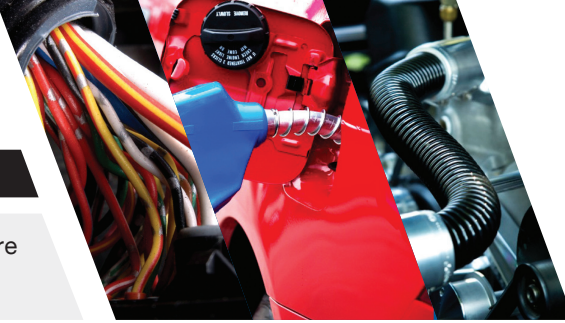

AUTOMOTIVE

ISO-9001 CERTIFIED

Utilizes state-of-the-art 3D CAD, CFD and FEA software to design a broad spectrum of tooling.



Photos & CAD shown are representative of Guill's growing line of advanced Automotive tooling. For the latest tooling design information ask your sales representative or contact Guill today.

ENGINEERING PRODUCT CAPABILITIES:

SINGLE PRESSURE / SINGLE TUBING / CO-EXTRUSION PRESSURE / CO-EXTRUSION TUBING / CO-EXTRUSION TUBE ON TUBE / TRIPLE PRESSURE / TRIPLE TUBE / MULTIPLE STRIPES / MULTI-LUMEN / INTERLOCKING LAYERS / SPIRAL FLOW / C.V. STEAM TUBE / CUSTOM DESIGNS



300 ROTARY

- ▣ Overall increases tube strength
- ▣ Achieves concentric walls at all speeds
- ▣ Low inventory / Quick color change
- ▣ Eliminates secondary stage processing

400 CORRUGATING DESIGN

- ▣ Multi-port spiral flow design
- ▣ Patented SealRite system for leak-free performance
- ▣ Designed for easy cleaning
- ▣ Quick change tooling

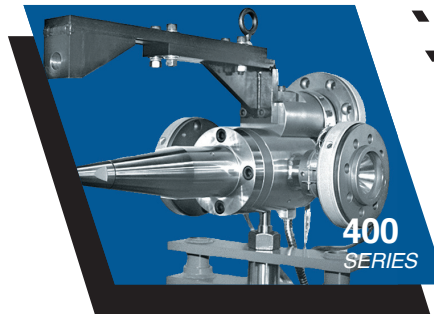

500 RUBBER, SILICONE & CV

- ▣ Achieve concentric walls at all speeds
- ▣ Fixed center or fully adjustable
- ▣ Quick change tooling
- ▣ Multi-layer capability
- ▣ Low inventory / Quick color-change
- ▣ Fast and easy to clean
- ▣ Internal cooling

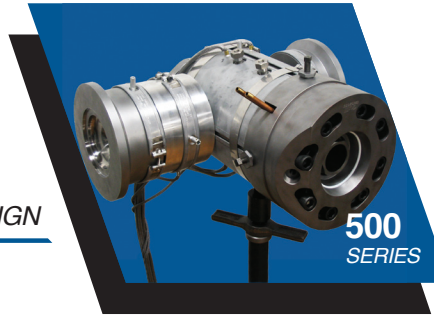

700 CROSS-HEAD

- ▣ Multi-port spiral flow design
- ▣ Patented SealRite system for leak-free performance
- ▣ High-speed / High-volume applications
- ▣ Can accept your existing tooling
- ▣ External band heaters

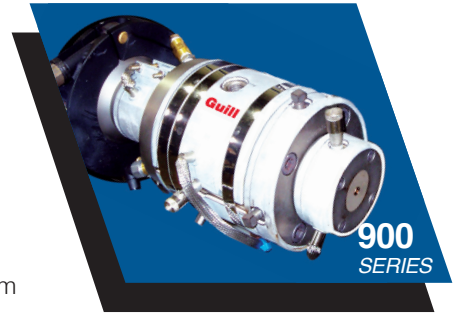
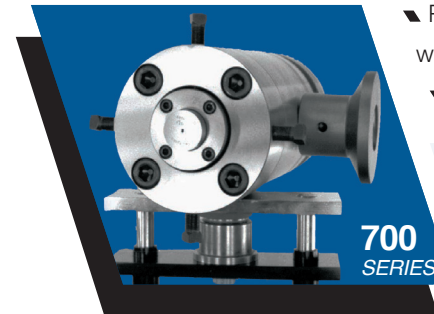

900 IN-LINE DESIGN

- ▣ Ultra low-volume design to minimize residence time
- ▣ Replaceable spiral flow inserts
- ▣ Rotary design for thin wall, high strength tubing
- ▣ Compact design

To view the benefits of Guill crossheads and dies, see page 2.

BUILDING PRECISION TOOLING FOR BETTER EXTRUSION

ISO-9001 CERTIFIED

GULL TOOL & ENGINEERING CO., INC. IS COMMITTED TO MEETING THE NEEDS OF OUR CUSTOMERS. REQUIREMENTS OF ANSI/ASQC Q9001-2000 INTERNATIONAL STANDARDS (ISO 9001) ARE COMMUNICATED AND MAINTAINED AT ALL LEVELS OF THE COMPANY THROUGH TRAINING, INTERNAL AUDITS AND INTERNAL COMMUNICATION. EACH PERSON IN OUR COMPANY IS DEDICATED TO DELIVERING QUALITY PRODUCTS AND OUTSTANDING SERVICE.

- ▀ CUSTOM DESIGNS AVAILABLE
- ▀ GULL EXTRUSION DIES RANGE FROM 0.127 MM (.005") DIAMETER MULTI-LAYER TUBES TO 508 MM (20.00") DIAMETER PIPES

300 SERIES

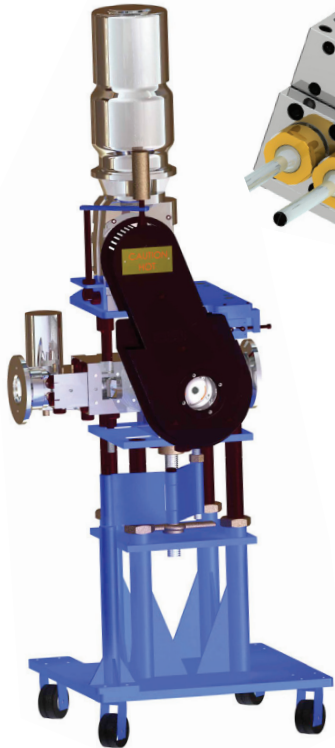

400 SERIES

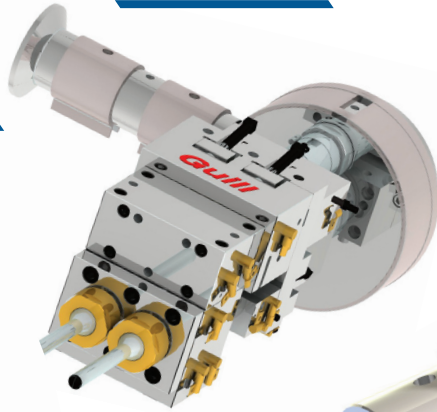

500 SERIES

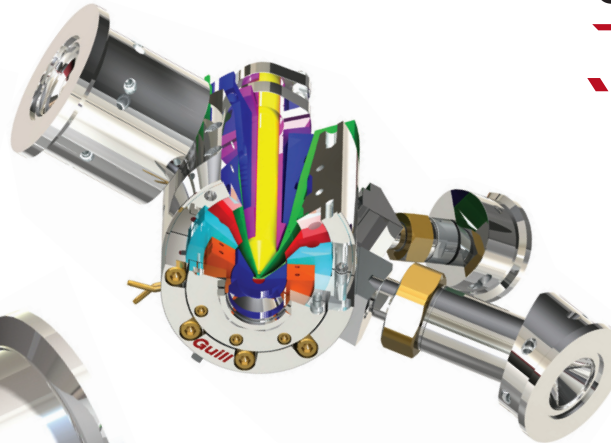

700 SERIES

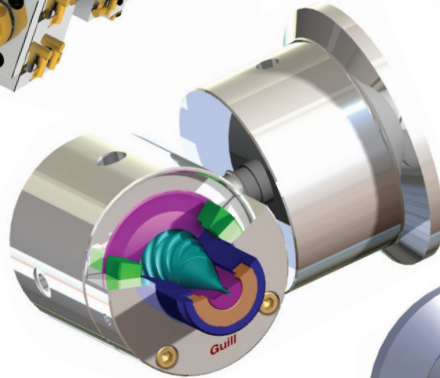

900 SERIES

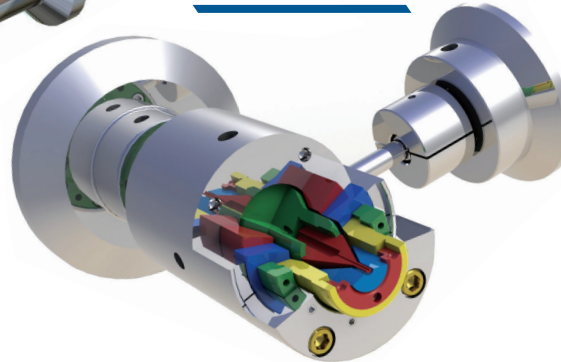

Optional Features

- ▀ Available as Fixed, Adjustable, FeatherTouch or Micro concentricity adjustment
- ▀ Single and multi-layer applications
- ▀ Surface, embedded or window striping
- ▀ Manual or pneumatic purge valves
- ▀ Quick color-change valves
- ▀ Flow control valves
- ▀ Variable extruder orientation
- ▀ Internal heaters to ensure even heat
- ▀ Multi-lumen applications
- ▀ Vacuum adapter

Additional Features

- ▀ Quick-change tooling
- ▀ Includes an assembly / disassembly tool kit
- ▀ Detailed digital operator manual
- ▀ Air adapter